

RECTIFIERS

High Efficiency, 1A

UES1001-UES1003

2

FEATURES

- Very Fast Recovery Times
- Very Low Forward Voltage
- Small Size
- Convenient Package

DESCRIPTION

An axial leaded power rectifier useful in many switching applications. Particularly suited where very fast recovery and low forward voltage are required.

ABSOLUTE MAXIMUM RATINGS

Peak Inverse Voltage, UES1001	50V
Peak Inverse Voltage, UES1002	100V
Peak Inverse Voltage, UES1003	150V
Maximum Average D.C. Output Current at $T_L = 75^\circ\text{C}$, $L = 3/8"$	1A
Non-Repetitive Surge Current at 8.3ms	30A
Thermal Resistance at $L = 3/8"$	75°C/W
Operating and Storage Temperature Range	$-55^\circ\text{C} + 175^\circ\text{C}$

ELECTRICAL SPECIFICATIONS

Type	PIV	Maximum Forward Voltage (V_F) @		Maximum Reverse Current (I_R) @ PIV		Maximum Reverse Recovery Time*
		$T_J = 25^\circ\text{C}$	$T_J = 100^\circ\text{C}$	@ $T_J = 25^\circ\text{C}$	@ $T_J = 100^\circ\text{C}$	
UES1001	50V	.975V	.895V	2 μA	50 μA	25nS
UES1002	100V	@	@			
UES1003	150V	1A	1A			

*Measured in circuit $I_F = .5\text{A}$, $I_R = 1.0\text{A}$, $I_{REC} = .25\text{A}$

MECHANICAL SPECIFICATIONS

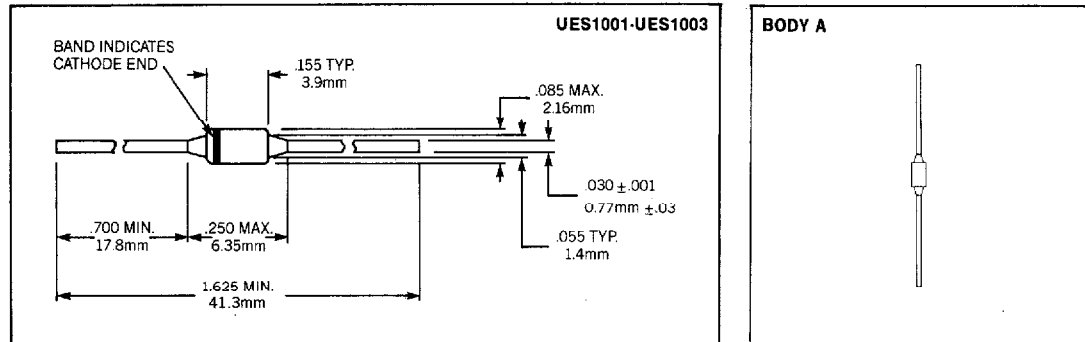

THESE DEVICES ALSO AVAILABLE IN SURFACE MOUNT PACKAGE. SEE SECTION 10

Output Current vs. Lead Temperature

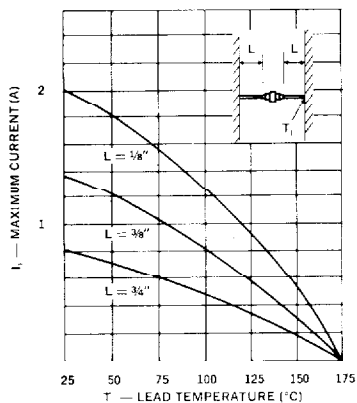

Typical Forward Current vs. Forward Voltage

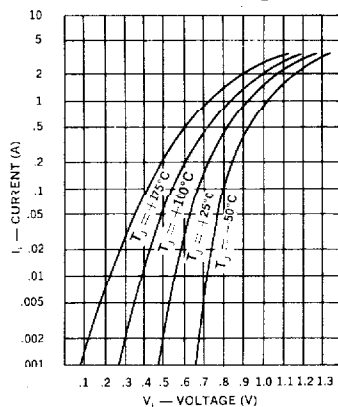

Typical Reverse Current vs. Voltage

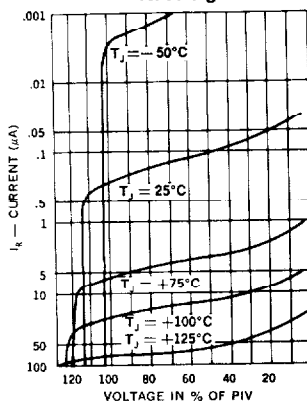

Peak Output Current vs. Lead Temperature

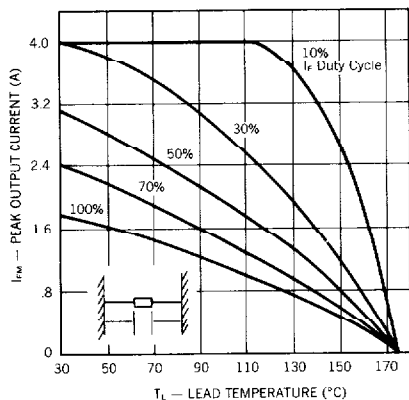

Forward Pulse Current vs. Duration

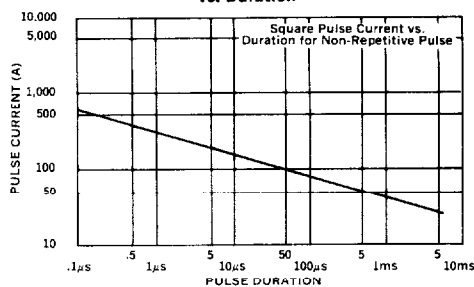

Multiple Surge Current vs. Duration

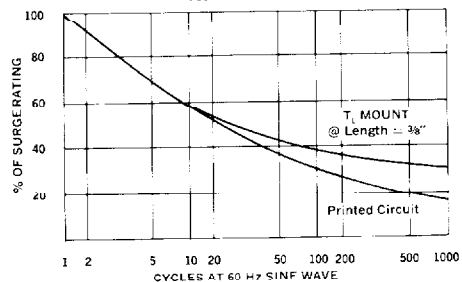

Reverse-Recovery Circuit

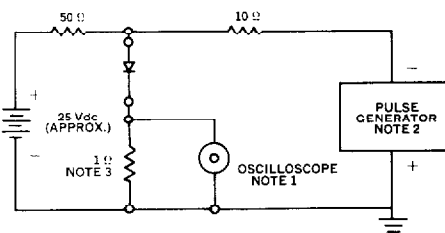

NOTES:

1. Oscilloscope: Rise time $\leq 3\text{ns}$; input impedance = 50Ω .
2. Pulse Generator: Rise time $\leq 8\text{ns}$; source impedance 10Ω .
3. Current viewing resistor, non-inductive, coaxial recommended.